

Integrated Monitoring and Control System for Building Air Conditioning

System Controller

UTY-APGX

- Powerful support from energy saving management function achieves significant energy savings for the overall building air conditioning.
- Both centralized control and remote monitoring control are achieved using one controller.
- A user-friendly interface makes overall management simple.



Energy Saving & Various Managements

Large buildings or multiple buildings can be batch controlled and monitored.

System Controller meets the diverse needs for building air conditioning from detailed individual air conditioning control to efficient operation and management of the entire building and management company remote support.



Diverse air conditioning energy saving management

Saves the outdoor unit capacity to suppress electric power consumption during peak use and controls peak cut operation to systematically maintain the target power consumption. In addition, a variety of power saving control functions, such as indoor unit rotation that alternately operates individual indoor units, are used to economically manage building air conditioning. (Optional)



The electricity charge apportionment function controls the electricity charges for the air conditioning

Calculates for the owner of the electricity charges used for air conditioning in tenant buildings and other properties. It can flexibly handle the apportionment method to tenants and a variety of electricity charge systems.



Remote monitoring control via the Internet

Operation can be remotely controlled and monitored via the Internet or a telephone line. A maximum of 10 properties can be remotely monitored and a single property can be monitored by multiple monitoring systems.



Diverse operation management

Building air conditioning can be systematically operated and managed throughout the year using annual schedule management in accordance with the operation plan, an easy-view operation status history management, and other tools.

Max. controllable

1,600 indoor units

Max. controllable

400 outdoor units

Max. controllable

4 VRF network systems

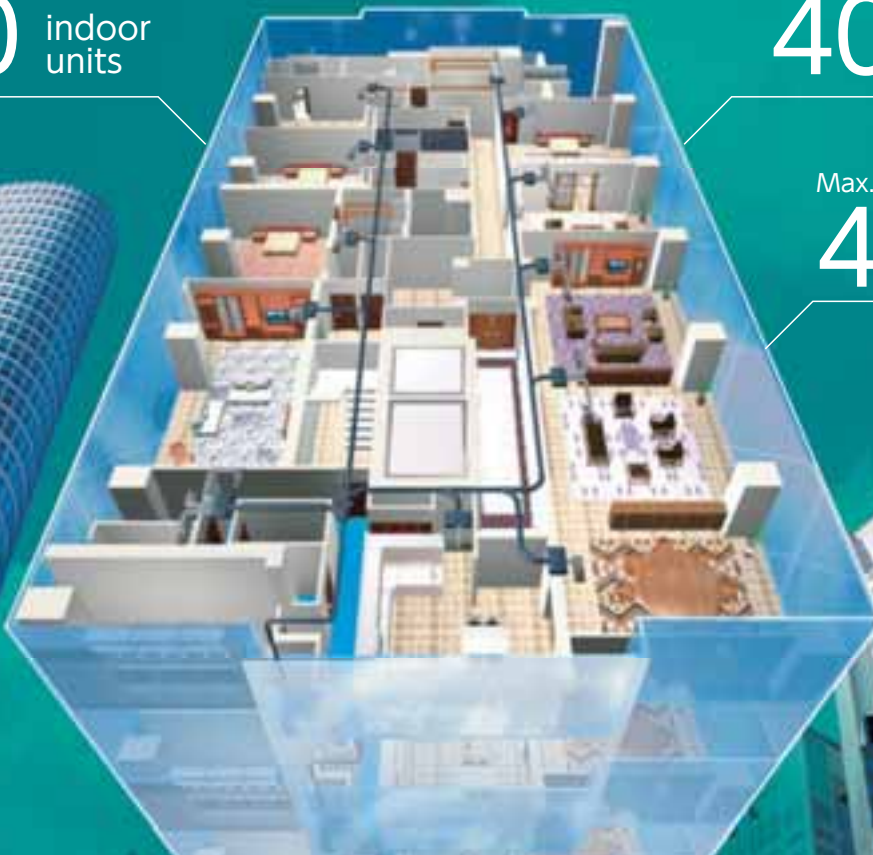

Easy Operation

Click & Operate

The property is shown visually from the perspective most suitable for operation and operated accordingly (Click & Operate). You can select from among the 4 displays of site, building, floor, or list.

Freely define groups for batched control

Indoor units can be freely grouped for simple batched control from a tree menu. Grouping by hierarchal structure, such as by section, division or department is possible.

Easy-to-use tree menu

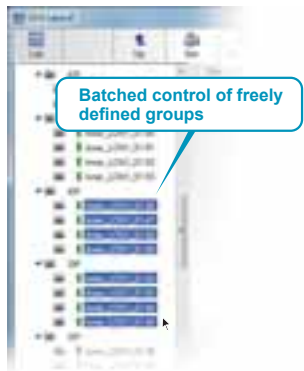

User interface provides intuitive operation

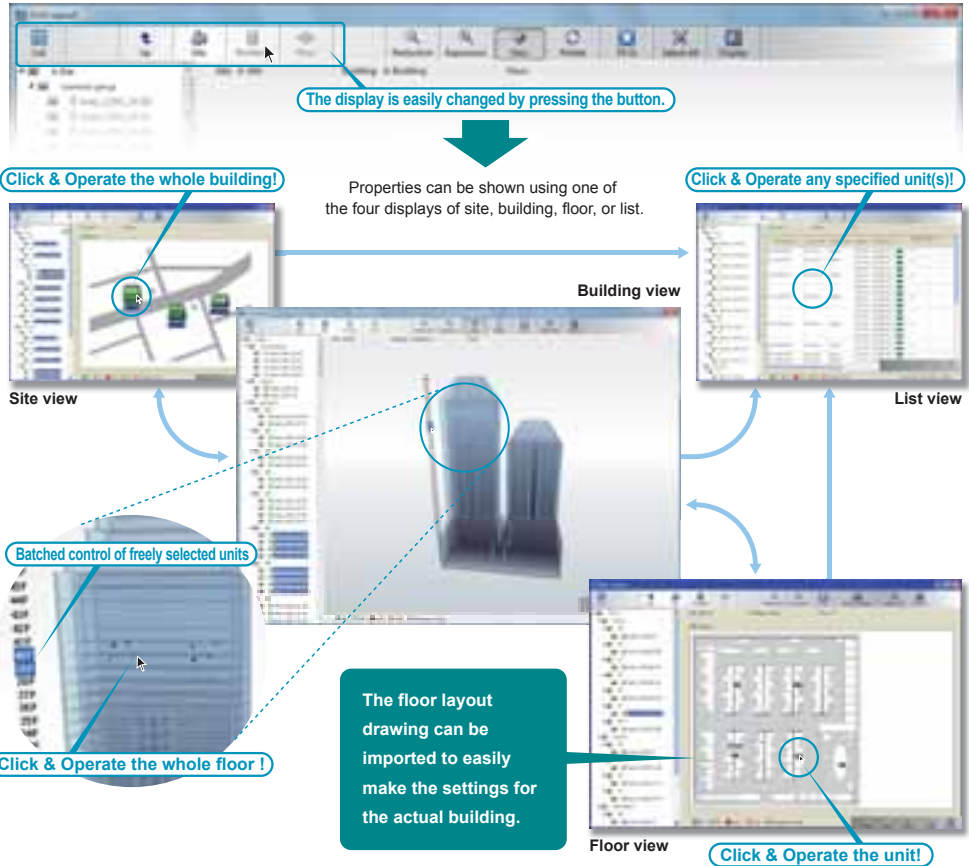

System configuration

1 VRF network system

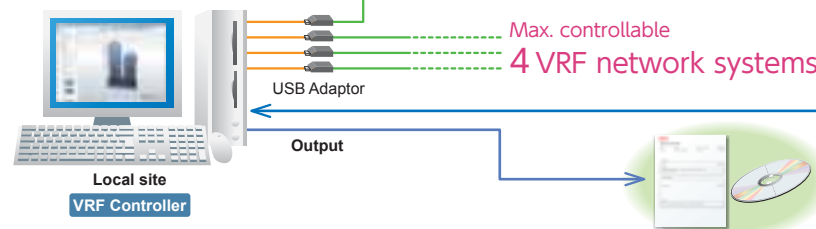
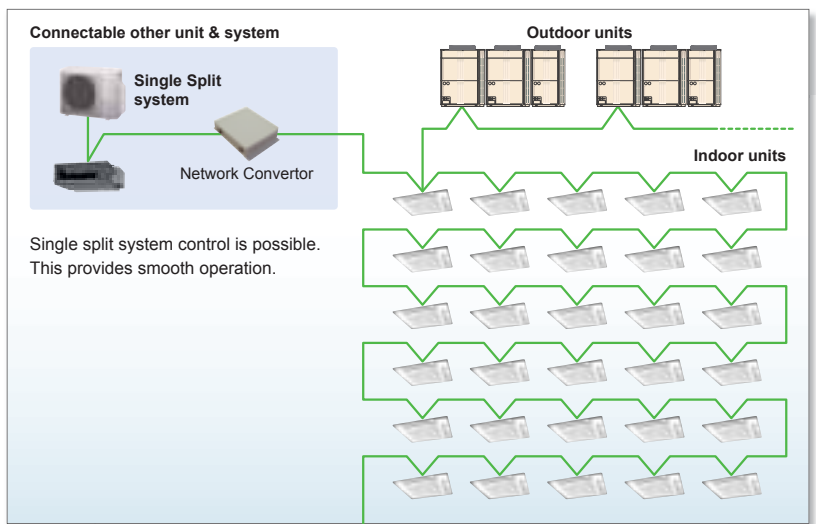

Building management company

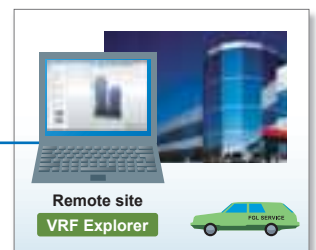

- 1 VRF Explorer can control or monitor up to **10 sites**.
- 1 VRF Controller can be monitored from any number of VRF Explorers (Up to 5 connections simultaneously).

VRF Controller

VRF controller is one of the programs that make up the System Controller, and it controls VRF Network and operates as the server for VRF Explorer.

VRF Explorer

VRF Explorer is another program that makes up the System Controller, and it administers the user interface for the local and remote sites to provide an intuitive user-friendly interface.

Internet or Telephone Line or LAN

Electricity charges and various history reports

Energy Saving Management With UTY-PEGX Option

A variety of energy saving operations can be set and managed depending on the season, weather, and time period. Excellent energy saving operation is performed while keeping users comfortable.



Energy Saving Management Main Screen

Energy saving graph data: This graph compares the electricity consumption with the previous month and previous year to make it easy to analyze the energy saving effect.

Peak cut operation Option

A power meter is connected to detect the total power consumption while shifting the indoor unit set temperature, set the indoor unit forced thermostat off, and taking other measures to carefully control the power consumed while maintaining comfort and conducting control to maintain the target power consumption set for each time. The indoor units to be controlled can be freely grouped and the control level can be set.

Outdoor unit stop range Forced thermostat off range Target power consumption

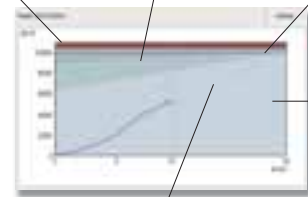

Ideal control line (Use of average power consumption)

Shows change in power consumption by time

Outdoor unit capacity save Option

Outdoor unit capacity save switches the outdoor unit capability upper limit to suppress power consumption during hot summers and cold winters by averaging the power saving effect of each refrigerant system. You can select from 50% or more of the capacity upper limit.



Outdoor unit capacity control screen

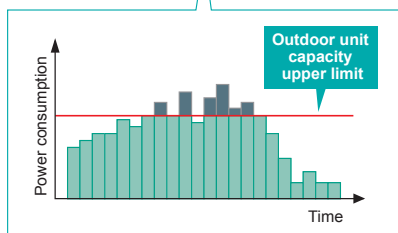

Outdoor unit capacity upper limit

Indoor unit rotation operation Option

The operation of indoor units can be automatically rotated within a group in accordance with the set annual schedule to reduce power consumption while maintaining comfort. The indoor unit operation stoppage rate can be selected.



Indoor unit rotation screen

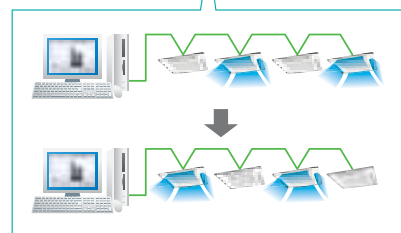

Upper and lower limit temperature setting

Sets the upper limit to lower limit range for the set temperature. Excessive temperature settings are prevented to control the energy saving.

Cooling setting temperature **26~28°C**
Heating setting temperature **22~24°C**

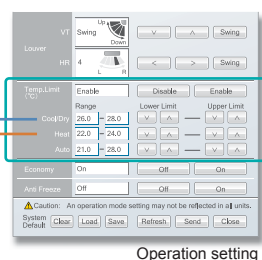

Operation setting

Batched stop

Batched stop at a freely set time for a property, building, or freely set block unit can be done to prevent any air conditioning unit from being forgotten to be turned off at the end of office hours, etc. In addition, any air conditioning unit whose operation is left on can be immediately identified by the icon color for a building or indoor unit in the monitoring screen and batched stop conducted in response.



Electricity charge apportionment

Electricity charge apportionment can be performed easily for the power consumed when billing users for air conditioning power charges, such as tenants in a commercial building, offices in a rental building, or rooms in a hotel.



With the electricity charge apportionment function, the power charges for the air conditioning used by each tenant can be calculated. Using the energy saving option (UTY-PEGX) allows for more detailed calculation of charges. The power consumption charges will evenly be divided among tenants depending on their usages.

Electricity charge apportionment calculation framework

Suppose you want to find the power consumed by the air conditioners of each tenant from the electricity charge for each month. With electricity charge apportionment function, used energy apportionment ratio will be provided, calculating in detail the energy consumed by the units used by each tenant. This information is then used to calculate the charges for the electricity consumed for air conditioning by each tenant from the total electricity charges in the bill from the electric power company. (See figure at right) The detailed calculation takes into consideration such things as unused rooms and nighttime electricity charges and shows them in a charges calculation sheet.

System Configuration Example

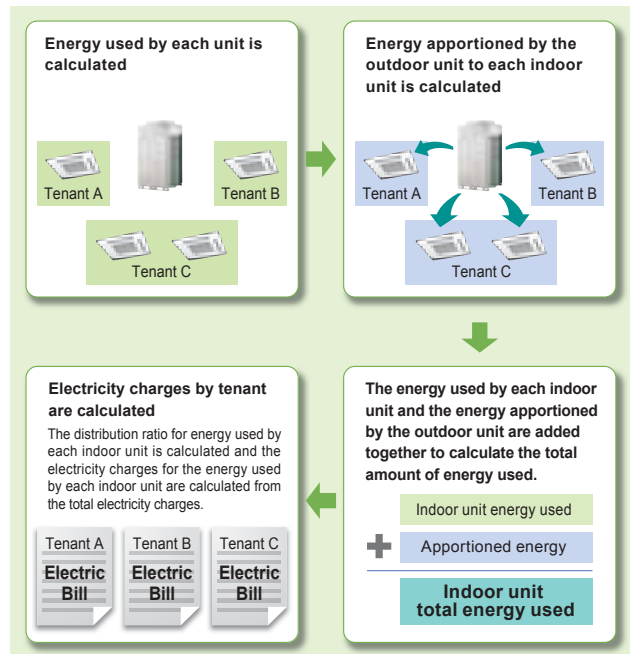
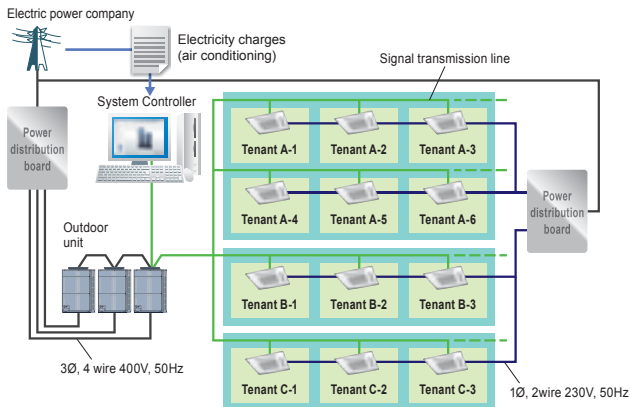

Configuration example of an electricity charge apportionment system with a power meter connected Option

Connecting a power meter allows the charges to be calculated for a variety of usage patterns such as charges for the power used on a per day basis or just the charges for the power used by the outdoor unit.

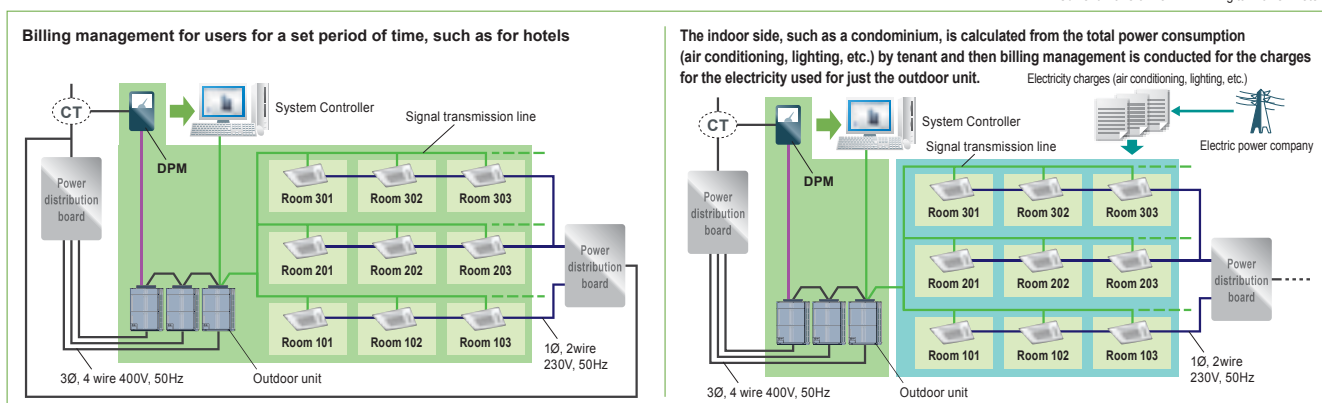

Note

- Multiple power meters can be installed taking into consideration the building design, etc.
- For example:
 - Install separate power meters for the outdoor units and indoor units
 - Install a power meter for the indoor units for each tenant
 - Install a power meter for the outdoor units/indoor units of each floor

- Power meters that can output a pulse for 1 kWh (1 kWh/pulse) for the power consumed by the air conditioning are recommended.
- There may be some restrictions on power meter installation depending on the property conditions.
- The electricity charge apportionment calculation does not comply with the laws and regulations of the various countries regarding measurement act.

Remote Management

Multiple air conditioning systems can be batched remote managed via the Internet. Alarm e-mails can also be sent.

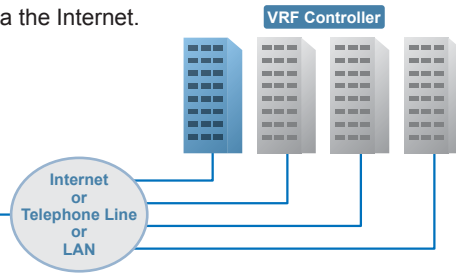
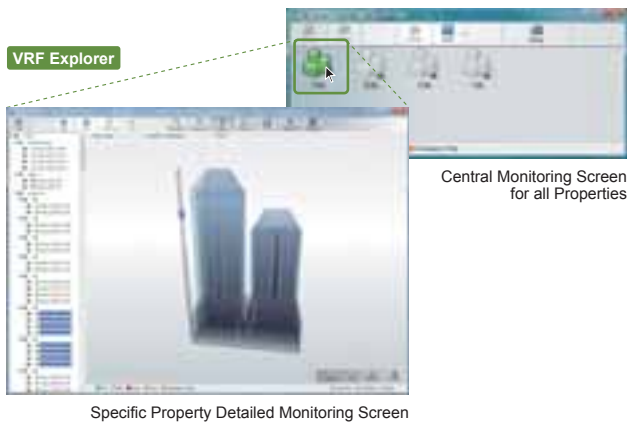

System Controller may be used on site or remotely over various networks for remote central control. System Controller requires 2 softwares working together. VRF Controller runs on site and communicate with VRF system. VRF Explorer runs remotely and provides user interface and communicate with the VRF Controller. VRF Controller and VRF Explorer program may run in a single PC or in different PCs separated by network. By using VRF Explorer software, one PC can perform central control of 10 VRF system sites with max. 20 buildings per site.

Flexible management

1 VRF Explorer can control or monitor up to 10 sites.

VRF Network Systems in a maximum of 10 locations can be controlled and monitored from a single VRF Explorer. This is optimum for operation of a large company or large shopping mall with multiple facilities on a single site.

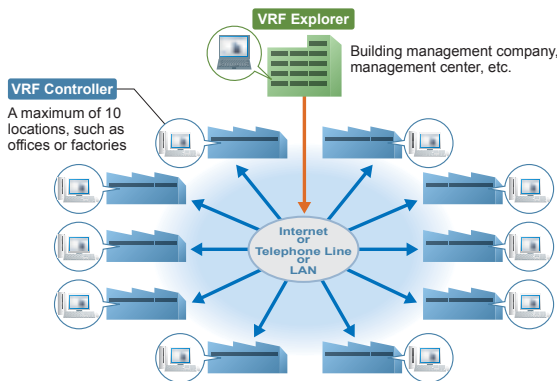

1 VRF Controller can be monitored from any number of VRF Explorers (Up to 5 simultaneous connections).

The building management company, security company, management center, etc., can use a single VRF system to remotely control, manage, and monitor simultaneously up to 5 locations from VRF Explorer. This makes it possible to operate the system with high reliability.

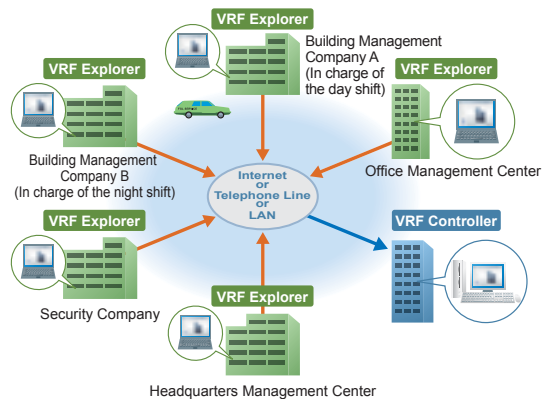

Can be used for a variety of applications



- Remote centralized management can be used for nighttime only to manage the air conditioning of multiple stores, operate air conditioning for people working overtime, and checking to see if employees forgot to turn off the air conditioning after they leave.
- Multiple users via a LAN can control the air conditioning in the office, general affairs department, or janitor's room.



- Batched operation of the factory buildings on a large site can be remotely conducted from the management office of the administration building to employ power saving operation.
- The headquarters can conduct centralized remote monitoring of the company's factories in outlying areas to improve the power saving effect for the entire company.



- Service companies that manage buildings that are empty at night after the managers leave to go home can conduct centralized remote monitoring of the building without dispatching employees to the site, which allows them to monitor the air conditioning for multiple clients.
- The System Controller remote monitoring and control functions can be used to receive outsourcing business from small and medium size building owners to manage their air conditioning energy.
- Nighttime only remote monitoring of multiple properties after the people leave can be performed for areas that require 24-hour operation, such as server rooms, to monitor for problems.



The air conditioning for franchise locations nationwide can be centrally controlled from headquarters to facilitate operation status and control to save energy.



- Remote batched control of satellite campuses can be performed from the main campus to achieve waste-free operation control.
- Controlling the operation of each building and each classroom on campus makes it possible to reduce expenses by remotely controlling those spaces in accordance with the teaching schedule.



In large hospitals with many buildings, the operation of air conditioning in each patient room can be remotely controlled from the control room in accordance with admission or discharge of patients.

Security Support



Employs SSL Encryption Technology

Encryption technology is used for communications to remote sites to prevent information from being stolen.



Detailed User Management

User identification: Authorization using user IDs and passwords is employed to prevent unauthorized access.

Access authority: The functions that can be used are restricted for individual login users to prevent unauthorized use.

Management of operation

Equipped with indispensable functions for operation from individual control to yearly operation schedule control and operation history and error history management



Schedule control

- Annual schedules can be set for each remote controller group / user defined group.
- Start / stop, operating mode, remote controller prohibition, and temperature settings can be set up to 143 times per day at 10 minute intervals for up to 101 configurations for each remote controller group.
- Settings can be made for periods straddling midnight.
- Allows programming of special settings for holidays, including public holidays, for a complete year.
- Low noise operation of outdoor unit can be scheduled.

Diverse control of indoor units

- Indoor unit operation state, operation mode, etc. are displayed
- Indoor unit start / stop and operation mode switching
- Temperature setting, Remote Controller prohibition.



Error display & E-mail notification

Error is notified with popup message, audible sound and E-mail real time when error occurs. Error for the past 1 year are logged and can be reviewed later.



Operating & control record

Displays the history of operation status and control.



Prohibition Setting

This prohibits changes to the operation mode, temperature, start/stop, etc.

Multiple language display

Corresponds to 7 different languages English, Chinese, French, German, Spanish, Russian, Polish.

System Controller Specification Summary

Type	Function	UTY-APGX	UTY-PEGX(*1) Option	Type	Function	UTY-APGX	UTY-PEGX(*1) Option
Status control	Multiple site display	●	—	Energy saving management	Indoor unit rotation	—	●
	Site display	●	—		Outdoor unit capacity save	—	●
	Layout display (building)	●	—		Meter operation setting	—	●
	Layout display (floor)	●	—		Peak cut control (data is preserved for 1 month)	—	●
	List display	●	—		Energy saving information	—	●
	Tree display	●	—		Power consumption information (data is preserved for 3 years)	—	●
Operation control	Control	●	—		Electricity charge apportionment	Apportionment charge calculation	●
	Remote control prohibited setting	●	—	Apportionment charge bill creation		●	—
	Set temperature upper and lower limit setting	●	—	Tenant (block) setting		●	—
	Low noise mode setting	●	—	Common facilities apportionment setting		●	—
	Schedule timer	●	—	Rated power consumption allotment setting		●	—
Error management	Error notification	●	—	Meter linked setting		—	●
	Error e-mail notification	●	—	Electricity charge apportionment data preservation (data is preserved for 2 years)		●	—
History management	Error history (data is preserved for 1 year)	●	—	Others	Group setting	●	—
	Remote operation history (data is preserved for 1 year)	●	—		Layout setting	●	—
	Memory operation	●	—		Database import/export	●	—
	Pattern operation	●	—		Multiple language display: English, Chinese, French, German, Spanish, Russian, Polish	●	●
					Floor layout import	●	—

Note: The S, V, and V-II series are supported, but with the S and V series, there are some functions that cannot be used, such as energy saving and using power meters.
*1: Energy Saving Software (UTY-PEGX) is available for the indoor units and the outdoor units after revision code B

Software configuration

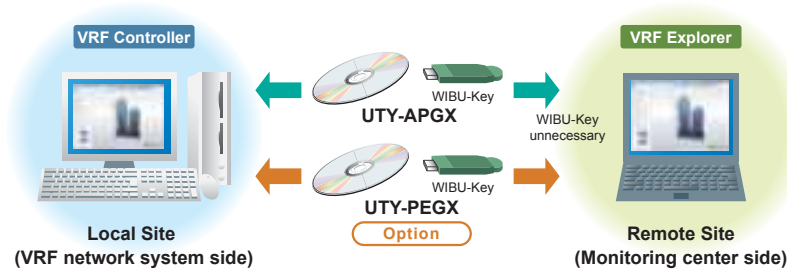

Any number can be installed in remote site personal computers. System Controller UTY-APGX can be installed in the local site PCs (VRF Controller) connected to the VRF network system and the multiple remote site PCs (VRF Explorer) connected to those computers via the Internet or LAN. Just this single product creates the control, management, and monitoring environment for the customer's properties including for remote operation.

*The WIBU-Key is not required for PCs on the remote site side. Some functions, such as equipment registration, and input/output, are not possible on the remote site side.

Optional software to strengthen the energy saving function
Installing the optional UTY-PEGX will strengthen the energy saving management function.

Operating Conditions

The following chart shows the detail requirement for an AT compatible personal computer to run System Controller. Applies for both VRF Controller and VRF Explorer PC.

Personal Computer		AT compatible machine that runs Microsoft® Windows®
	Operating System	Microsoft® Windows® XP Professional (Service Pack 3 or later / English version) Microsoft® Windows Vista® Home Premium, Business (Service Pack 2 or later / Corresponds to 7 different languages.*) Microsoft® Windows® 7 Home Premium, Professional (Corresponds to 7 different languages.*) *English, Chinese, French, German, Spanish, Russian, Polish *64-bit version of Windows® are not supported.
	CPU	Intel® Pentium® / Celeron 2 GHz (VRF Controller), 1 GHz (VRF Explorer) or higher
	HDD	40 GB or more of free space (5 GB for VRF Explorer PC)
	Memory	2 GB or more (VRF Controller), 1 GB or more (VRF Explorer)
	Display	1024 x 768 dots or more. 15 inch or higher size is preferable.
	Interface	USB port is required for each of the followings for Server PC ; • Wibu Key (Software protection key) • Echelon® U10 USB Network Interface (Required for each VRF Network) Ethernet port is required for remote connection using internet.
Accelerator		Requires the internal graphics accelerator be compatible with Microsoft® DirectX® 9.0
Other Software Required		Adobe® Reader® 9.0 or later

<OPTION AVAILABLE>

Energy Saving Software	UTY-PEGX(*1)	Additional support for energy saving function and Electricity Charge Apportionment using electricity meter.
------------------------	--------------	---

<PACKING LIST>

Item	Q'ty	Application
CD-ROM	1	Includes the software for System Controller. Both VRF Controller and VRF Explorer software is included.
Wibu Key (Software protection key)	1	Software protection key to be inserted in a USB slot running System Controller. System Controller may only run on a PC with Wibu Key. Remote VRF Explorer software does not require Wibu Key.

Personal computer must be field supplied. U10 USB Network Interface must be field supplied. Contact Echelon® Corporation or its local sales representative for detail.

Product Name : U10 USB Network Interface - TP/FT-10 Channel Model Number : 75010R

*1: Energy Saving Software (UTY-PEGX) is available for the indoor units and the outdoor units after revision code B

"**AIRSTAGE™**" is a worldwide trademark of FUJITSU GENERAL LIMITED and is a registered trademark in Japan, the U.S.A and other countries or areas.

*Microsoft® and Windows® are registered trademarks of Microsoft Corporation in the United States.

*Adobe® Reader® are registered trademarks of Adobe Systems Incorporated in the United States.

*Intel®, Pentium® and Celeron® are registered trademark of Intel Corporation or its subsidiaries in the United States.

*Echelon®, LONWORKS®, and the Echelon logo are trademarks of Echelon Corporation registered in the United States and other countries.

*BACnet® is a registered trademark of the American Society of Heating Refrigeration and Air Conditioning Engineers (ASHRAE).

The colors may be different from the actual colors because this catalog is printed matter.

Product specifications are subject to change without notice.

Distributed by :

FUJITSU GENERAL LIMITED

1116, Suenaga, Takatsu-ku, Kawasaki 213-8502, Japan

<http://www.fujitsu-general.com/>

Copyright© 2010 Fujitsu General Limited. All rights reserved.

6NNC00-1009E Printed in Japan